

Model 3110C

Biconical Antenna

User Manual



 **ETS-LINDGREN**[®]
An ESCO Technologies Company

ETS-Lindgren Inc. reserves the right to make changes to any product described herein in order to improve function, design, or for any other reason. Nothing contained herein shall constitute ETS-Lindgren Inc. assuming any liability whatsoever arising out of the application or use of any product or circuit described herein. ETS-Lindgren Inc. does not convey any license under its patent rights or the rights of others.

© Copyright 2000–2014 by ETS-Lindgren Inc. All Rights Reserved. No part of this document may be copied by any means without written permission from ETS-Lindgren Inc.

Trademarks used in this document: The *ETS-Lindgren* logo is a trademark of ETS-Lindgren Inc.

Revision Record | MANUAL 3110 | Part #399108, Rev. H

Revision	Description	Date
A–F	Initial Release; Updates	November, 2000– March, 2002
G	Updated content to Model 3110C; re-branding changes	May, 2008
H	Added optional 3110CP with portable elements; updated boom options	April, 2014

Table of Contents

Notes, Cautions, and Warnings	v
1.0 Introduction	7
Optional Items	7
Model 3110CP—Portable Elements	7
Tripod Options	8
ETS-Lindgren Product Information Bulletin	9
2.0 Maintenance	11
Annual Calibration	11
Replacement and Optional Parts	11
Service Procedures	12
3.0 Specifications	13
Electrical Specifications	13
Physical Specifications	13
Model 3110CP (With Portable Elements)	14
4.0 Assembly Instructions	15
5.0 Mounting Instructions	17
Using Included Mounting Adapters	17
Using the Stinger Mount	19
Additional Mounting Options	20
4-TR Mounting Options	20
7-TR and Mast Mounting Options.....	21
2x2 Boom Mounting Options	22
6.0 Application	23
7.0 Typical Data	25
Antenna Factor	25
Gain.....	26
VSWR.....	27
Half-Power Beamwidth	28
Appendix A: Warranty	29

This page intentionally left blank.

Notes, Cautions, and Warnings

	<p>Note: Denotes helpful information intended to provide tips for better use of the product.</p>
<p>CAUTION</p>	<p>Caution: Denotes a hazard. Failure to follow instructions could result in minor personal injury and/or property damage. Included text gives proper procedures.</p>
<p>WARNING</p>	<p>Warning: Denotes a hazard. Failure to follow instructions could result in SEVERE personal injury and/or property damage. Included text gives proper procedures.</p>



See the ETS-Lindgren *Product Information Bulletin* for safety, regulatory, and other product marking information.

This page intentionally left blank.

1.0 Introduction

The **ETS-Lindgren Model 3110C Biconical Antenna** is specifically designed for radiated emissions testing. This high-performance receive-only antenna operates within a frequency range of 30 MHz to 300 MHz.

The biconical elements are made from aluminum rods and are welded into a fixed assembly. The elements mount onto a balun network which is fabricated of aluminum and the necessary impedance-matching components. The lightweight construction provides for ease in portability and storage.

A variety of mounting options are available for the Model 3110C. For information, see *Mounting Instructions* on page 17.

Optional Items

MODEL 3110CP—PORTABLE ELEMENTS

Collapsible folding elements are available, making the Model 3110C portable and ideal for field use. Both the standard rigid and optional folding elements attach to the balun using screw mounts. This makes changing between the two types of elements quick and easy.

TRIPOD OPTIONS

ETS-Lindgren offers the following nonmetallic, non-reflective tripods for use at both indoor and outdoor EMC test sites.

- **Model 4-TR**—Constructed of linen phenolic and delrin, designed with an adjustable center post for precise height adjustments. Maximum height is 2.0 m (80.0 in), and minimum height is 94 cm (37.0 in). This tripod can support up to an 11.8 kg (26.0 lb) load.



- **Model 7-TR**—Constructed of PVC and fiberglass components, providing increased stability for physically large antennas. The unique design allows for quick assembly, disassembly, and convenient storage. Allows several different configurations, including options for manual or pneumatic polarization. Quick height adjustment and locking wheels provide ease of use during testing. Maximum height is 2.17 m (85.8 in), with a minimum height of 0.8 m (31.8 in). This tripod can support a 13.5 kg (30 lb) load.



ETS-Lindgren Product Information Bulletin

See the ETS-Lindgren *Product Information Bulletin* included with your shipment for the following:

- Warranty information
- Safety, regulatory, and other product marking information
- Steps to receive your shipment
- Steps to return a component for service
- ETS-Lindgren calibration service
- ETS-Lindgren contact information

This page intentionally left blank.

2.0 Maintenance

CAUTION

Before performing any maintenance, follow the safety information in the ETS-Lindgren *Product Information Bulletin* included with your shipment.



Maintenance of the Model 3110C is limited to external components such as cables or connectors.

If you have any questions concerning maintenance, contact ETS-Lindgren Customer Service.

Annual Calibration

See the *Product Information Bulletin* included with your shipment for information on ETS-Lindgren calibration services.

Replacement and Optional Parts

Following are the part numbers for ordering replacement or optional parts for the Model 3110C Biconical Antenna.

Part Description	Part Number
Element, Fixed Bicon with Cross Arm (2)	101808
Clamp Block	102108
Support Base	101942B
Support Rod White	100733
Model 3110CP (with portable elements)	3110CP



For additional/optional mounting hardware, see *Additional Mounting Options* on page 20.

Service Procedures

For the steps to return a system or system component to ETS-Lindgren for service, see the *Product Information Bulletin* included with your shipment.

3.0 Specifications

Electrical Specifications

Frequency Range:	30 MHz–300 MHz
VSWR Ratio (Average):	2.0:1
Maximum Continuous Power:	250 mW
Peak Power:	NA
Impedance:	50 Ω
Connector:	Type N female

Physical Specifications

Width:	132.1 cm 52.0 in
Depth:	55.9 cm 22.0 in
Diameter:	52.0 cm 20.5 in
Weight:	2.7 kg 6.0 lb



ETS-Lindgren recommends using a 6 dB pad attached to the end of the antenna; otherwise, high VSWR may occur.

MODEL 3110CP (WITH PORTABLE ELEMENTS)

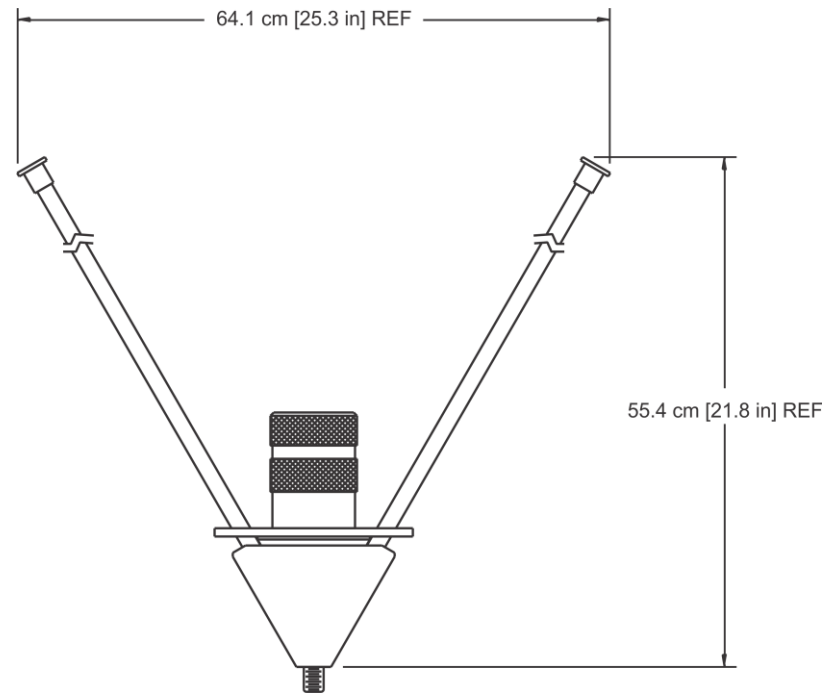

One element is shown for illustrative purposes only; all specifications are based on the balun plus both elements.

Width (includes elements and balun):	120.9 cm (47.6 in)
Diameter:	64.1 cm (25.3 in)
Weight (includes elements and balun):	1.9 kg (4.2 lb)

4.0 Assembly Instructions

CAUTION

Before connecting any components, follow the safety information in the ETS-Lindgren *Product Information Bulletin* included with your shipment.

The Model 3110C Biconical Antenna is shipped unassembled, and includes these parts:

- Balun – includes attached stinger mount
- Biconical element (2)
- Belleville washer (2)
- Clamp block
- Support rod and support base

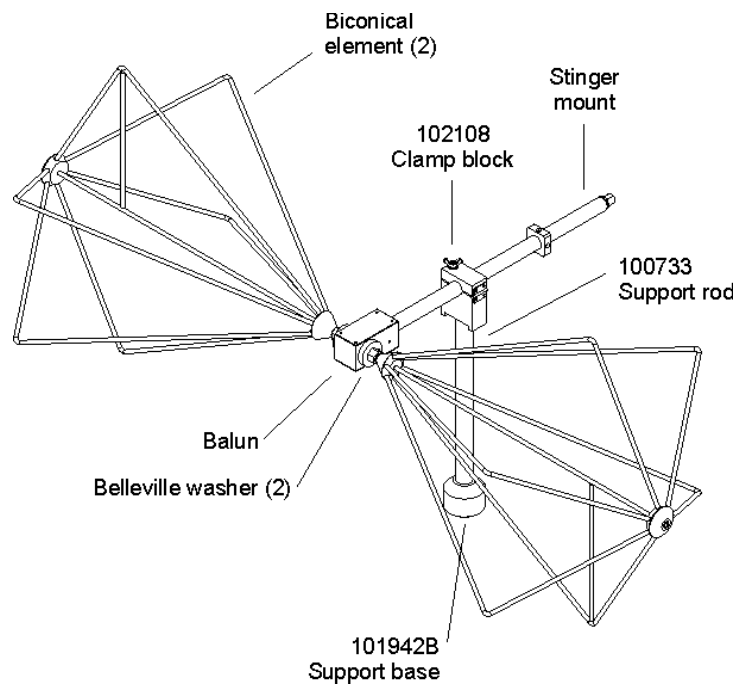

To assemble the Model 3110C:

1. Slide a belleville washer onto the threaded screw end of one of the biconical elements.
2. Line up the screw threads with the receptacle hole on the balun and turn the biconical element until it is firmly secured in the balun.

CAUTION

Do not cross thread this connection or permanent damage to the joint could occur.

3. Repeat step 1 and step 2 using the remaining washer and biconical element.

5.0 Mounting Instructions

CAUTION

Before connecting any components, follow the safety information in the ETS-Lindgren *Product Information Bulletin* included with your shipment.

CAUTION

The Model 3110C is a precision measurement device. Handle with care.

Using Included Mounting Adapters

The Model 3110C Biconical Antenna ships with these mounting adapters:

- **102108 Clamp Block**—Uses standard 7/8–14 threads and comes with a 1/4–20 thread adapter for mounting to an ETS-Lindgren tripod or most other tripods.

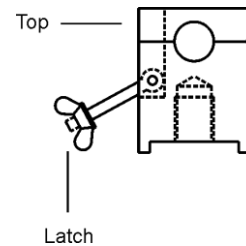

- **101942B Support Base**

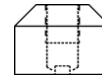

- **100733 Support Rod**



To use these adapters to mount the Model 3110C to a 4-TR tripod:

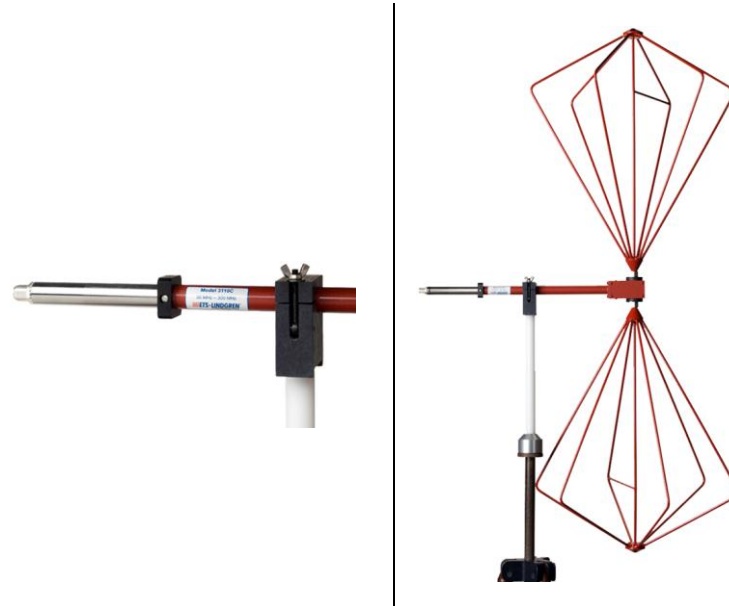

**Shown mounted onto a 4-TR with clamp block,
support base, and support rod**

1. Assemble the clamp block, support base, and support rod, and attach the support base to the 4-TR tripod.
2. Unscrew the clamp block latch and open the top.
3. Insert the balun into the clamp block and close the top over the balun.
4. Move the latch to the closed position and tighten so the balun is held securely.
5. Attach the cable to the output connector on the antenna.

Using the Stinger Mount

The stinger on the Model 3110C enables you to mount to antenna directly to an ETS-Lindgren 7-TR Tripod Positioner or mast.



Additional hardware is required to use the stinger to mount the Model 3110C to a mast. For information on ordering optional mounting hardware, contact the ETS-Lindgren Sales Department.



Shown stinger-mounted onto a 7-TR



Do not use the stinger to mount the Model 3110C onto a 4-TR tripod.

Additional Mounting Options

4-TR MOUNTING OPTIONS

Following are additional options for mounting the Model 3110C onto an ETS-Lindgren 4-TR tripod. Contact the ETS-Lindgren Sales Department for information on ordering optional mounting hardware.

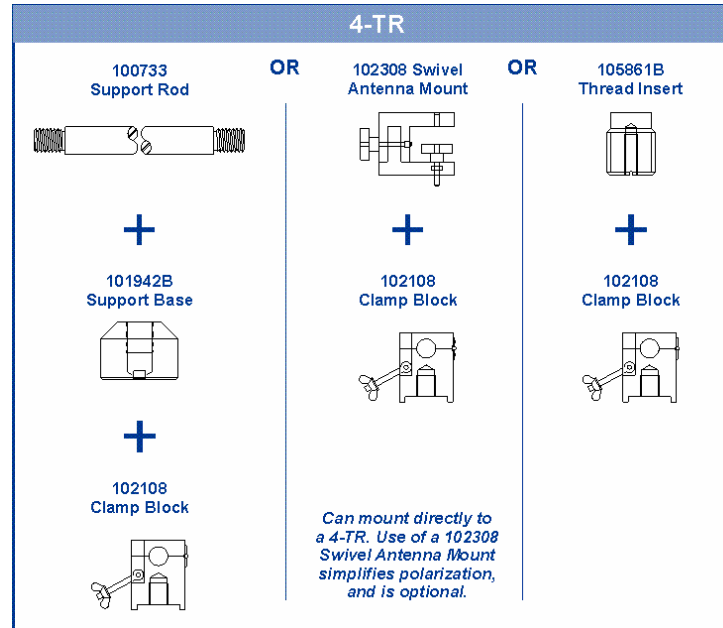

7-TR AND MAST MOUNTING OPTIONS

The stinger on the Model 3110C enables you to mount the antenna directly to an ETS-Lindgren 7-TR Tripod Positioner. Following are non-stinger options for mounting the Model 3110C onto an ETS-Lindgren 7-TR Tripod Positioner.

Contact the ETS-Lindgren Sales Department for information on ordering optional mounting hardware.



Mast refers to 2070 Series, 2075, and 2175 Antenna Towers.

7-TR refers to these booms:

- *109042 boom*—Straight boom; for general antenna mounting on a 7-TR
- *108983 boom*—Offset boom; for general antenna mounting on a 7-TR with pneumatic or manual polarization; can also be used to mount stinger-type antennas

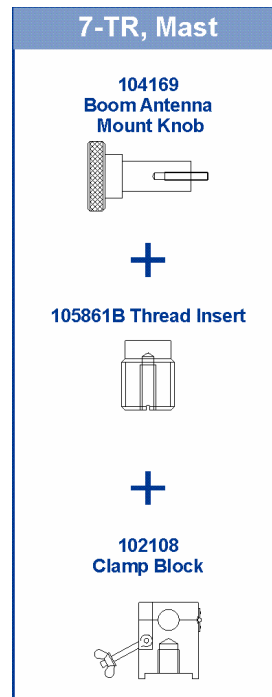

2x2 BOOM MOUNTING OPTIONS

Following are additional options for mounting the Model 3110C onto a 2x2 boom. Contact the ETS-Lindgren Sales Department for information on ordering optional mounting hardware.



2x2 boom refers to a typical 2-inch by 2-inch boom.

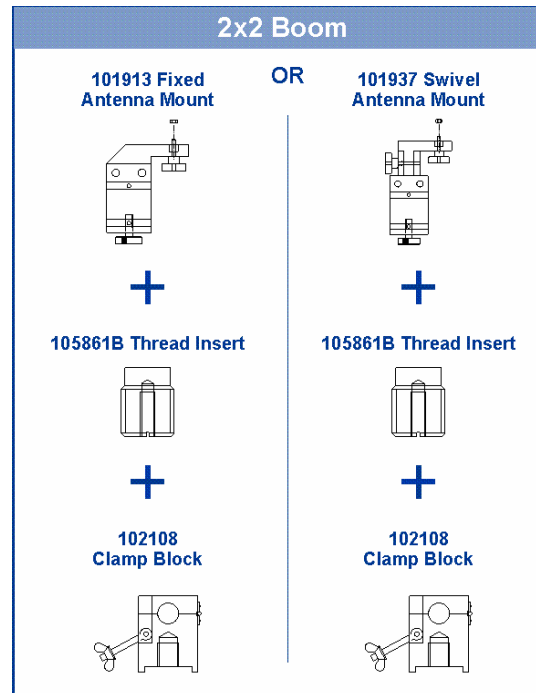

6.0 Application

The Model 3110C Biconical Antenna is ideally suited for swept site attenuation measurements per ANSI and FCC specifications. The Model 3110C can be used for horizontal and as vertical site attenuation measurements. A 20 dB pre-amplifier is recommended in line with the receive antenna to minimize the required transmitted power and to reduce the possibility of saturation of the transmitting antenna. The maximum continuous input power to the Model 3110C is 250 mW.

When the Model 3110C is used vertically, the same element orientation need not be maintained from measurement to measurement. The Model 3110C exhibits excellent symmetrical performance, and test repeatability is assured by the balun design.

Each antenna is calibrated during manufacturing. The results of the calibration are tabulated as gain and antenna factor vs. frequency for use in Specification Compliance Testing. Typical data for the Model 3110C is provided in the next section.

This page intentionally left blank.

7.0 Typical Data

Antenna Factor

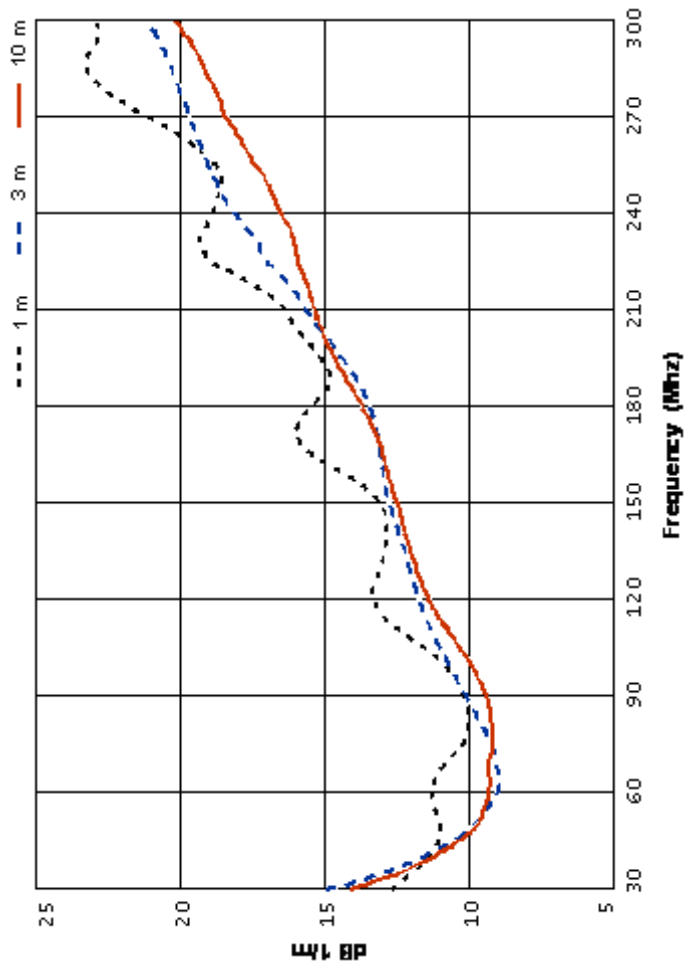

Gain

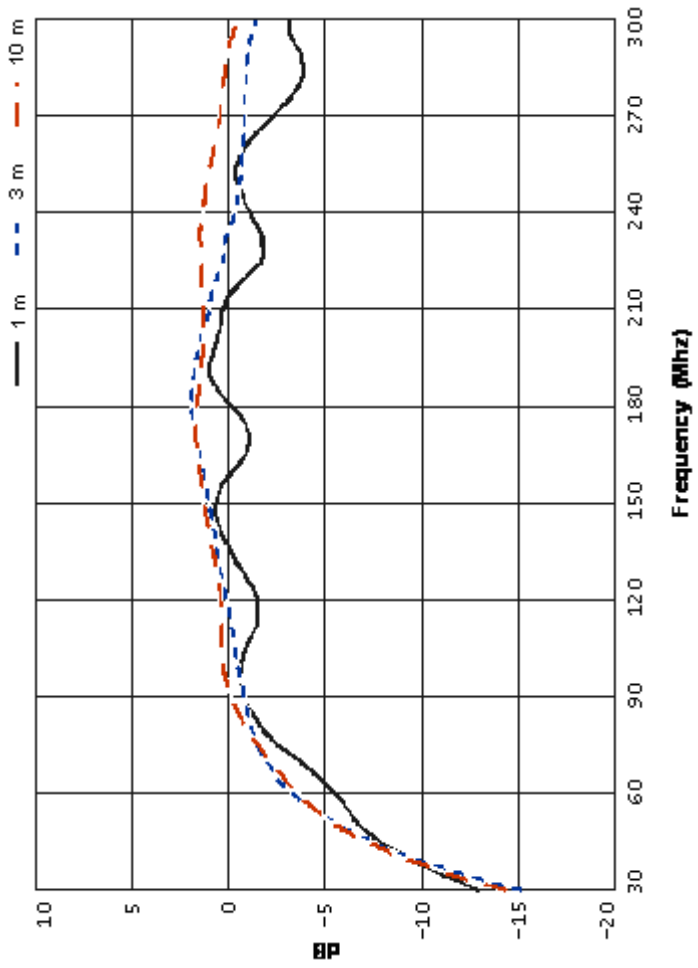

VSWR

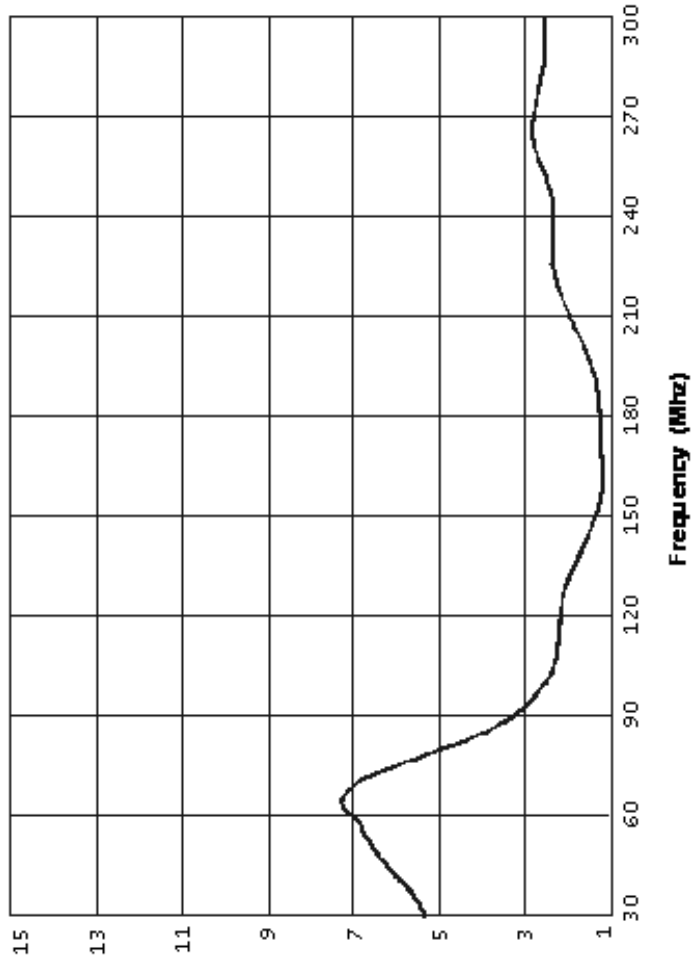

Half-Power Beamwidth

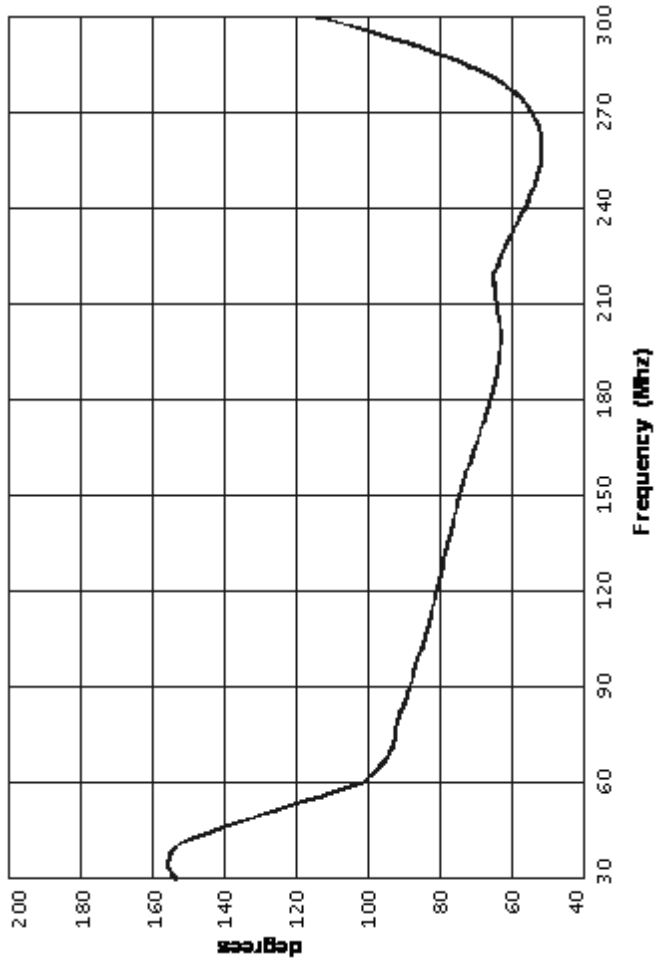

Appendix A: Warranty



See the *Product Information Bulletin* included with your shipment for the complete ETS-Lindgren warranty for your Model 3110C Biconical Antenna.

DURATION OF WARRANTIES FOR MODEL 3110C

All product warranties, except the warranty of title, and all remedies for warranty failures are limited to two years.

Product Warranted	Duration of Warranty Period
Model 3110C Biconical Antenna	2 Years