

*Model 2110CR / Model 2115CR / Model 2120CR*

# **Continuous Rotation Multi-Axis Positioning System (MAPS™)**

**User Manual**

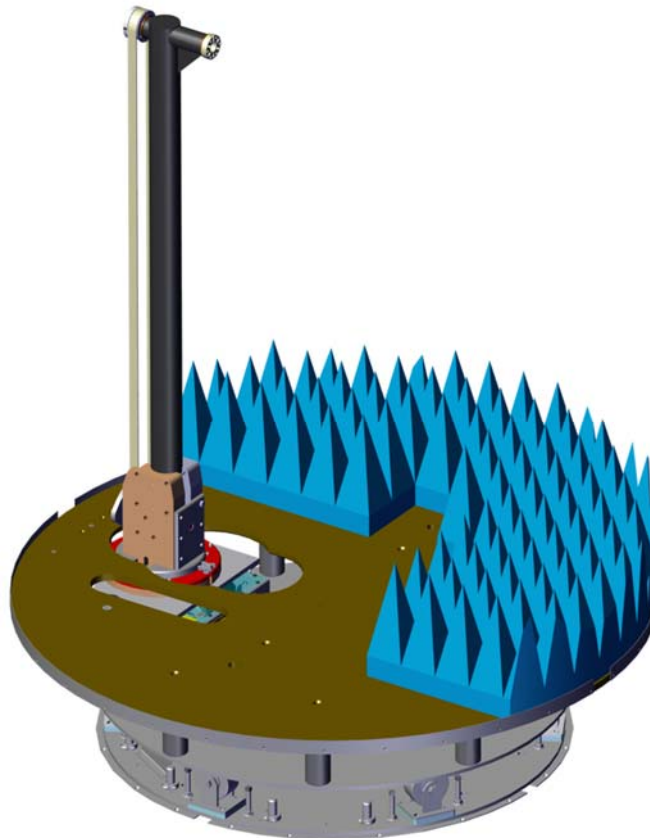

*Model 2115CR Medium Duty MAPS (partial assembly shown)*

**ETS-LINDGREN**<sup>®</sup>  
An ESCO Technologies Company

ETS-Lindgren Inc. reserves the right to make changes to any products herein to improve functioning or design. Although the information in this document has been carefully reviewed and is believed to be reliable, ETS-Lindgren does not assume any liability arising out of the application or use of any product or circuit described herein; nor does it convey any license under its patent rights nor the rights of others. All trademarks are the property of their respective owners.

**© Copyright 2009–2018 by ETS-Lindgren Inc. All Rights Reserved. No part of this document may be copied by any means without written permission from ETS-Lindgren Inc.**

Trademarks used in this document: The *ETS-Lindgren* logo is a registered trademark, and *MAPS*, *EMCenter*, and *EMControl* are trademarks of ETS-Lindgren Inc.

### Revision Record

**MANUAL,2110CR 2115CR 2120CR MAPS | Part # 399308, Rev. E**

Revision	Description	Date
A	Initial Release	October, 2009
B	Added Model 2110CR content	February, 2010
C	Added MAPS compatibility information	April, 2010
D	Added Model 2120CR content	June, 2015
E	Changed 2090 to EMCenter™	January, 2018

# Table of Contents

- Notes, Cautions, and Warnings ..... v**
- 1.0 Introduction ..... 7**
  - Standard Configuration..... 8
    - Mast ..... 8
    - Horizontal Roll Axis ..... 8
    - Turntable ..... 8
    - Motor Bases ..... 9
    - Fiber Optic Cables ..... 9
    - Tension Scale ..... 9
  - Positioning Controller ..... 10
  - ETS-Lindgren Product Information Bulletin ..... 11
- 2.0 Maintenance ..... 13**
  - Using the Tension Scale to Measure and Set Belt Tension ..... 13
  - Routine Maintenance..... 15
  - Bi-Annual Maintenance ..... 16
  - Annual Maintenance ..... 16
  - Replacement and Optional Parts..... 16
    - Replacement parts ..... 16
    - Optional Parts–2115CR Only..... 17
  - Service Procedures ..... 18
    - Contacting ETS-Lindgren..... 18
    - Sending a Component for Service ..... 18
    - Calibration Services and Annual Calibration ..... 18
- 3.0 Specifications ..... 19**
  - Electrical Specifications..... 19
  - Physical Specifications ..... 19
  - Mast Specifications..... 19
- 4.0 Electrical Installation ..... 21**
- 5.0 Installation ..... 23**
  - Required Tools ..... 23
  - Reference Point..... 24
  - System Installation ..... 25
    - Anchor Plate Installation ..... 26
    - Upper Drive Unit Removal ..... 27

Bore Sight and Leveling .....	29
Bore Sight .....	29
Leveling and Height Adjustment .....	34
Controller Interface .....	36
Absorber Installation .....	36
<b>6.0 Operation .....</b>	<b>37</b>
EMCenter Parameter Settings.....	37
<b>Appendix A: Warranty .....</b>	<b>38</b>
Duration of Warranties.....	38
<b>Appendix B: Assembly Drawings.....</b>	<b>40</b>

## Notes, Cautions, and Warnings

---



**Note:** Denotes helpful information intended to provide tips for better use of the product.



**CAUTION:** Denotes a hazard. Failure to follow instructions could result in minor personal injury and/or property damage. Included text gives proper procedures.



**WARNING:** Denotes a hazard. Failure to follow instructions could result in **SEVERE** personal injury and/or property damage. Included text gives proper procedures.



**Note:** See the ETS-Lindgren *Product Information Bulletin* for safety, regulatory, and other product marking information.

This page intentionally left blank.

## 1.0 Introduction

---

The **ETS-Lindgren Continuous Rotation (CR) Multi-Axis Positioning System (MAPS™)** is available in three models:

- **2110CR Light Duty**
- **2115CR Medium Duty**
- **2120CR Heavy Duty**

The CR MAPS are designed to perform measurements of spherical antenna patterns as well as total and effective isotropic radiated power of wireless devices.

The CR MAPS provides independent rotation in both horizontal and vertical axes. In addition, the CR MAPS rotates continuously around the vertical axis.

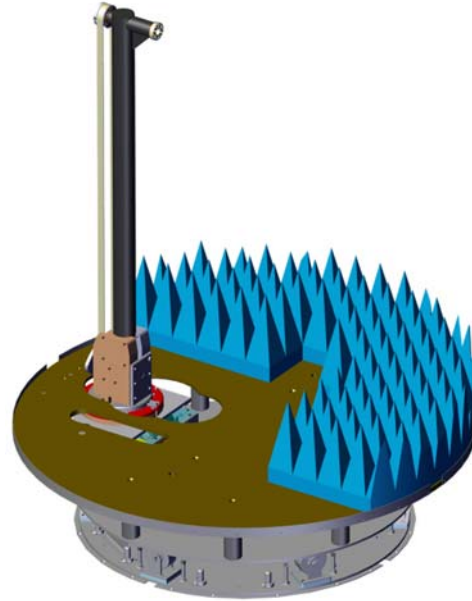

*Model 2115CR Medium Duty MAPS  
(partial assembly shown)*

The CR MAPS is built according to the customer-specified height by reducing the vertical support column to the appropriate length; the height of this axis must be specified when placing the order. A motor drive at the base of the vertical support column controls the movement of the CR MAPS, in conjunction with a positioning controller (sold separately), such as the EMCenter™ Modular RF Platform. For more information, see page 9.

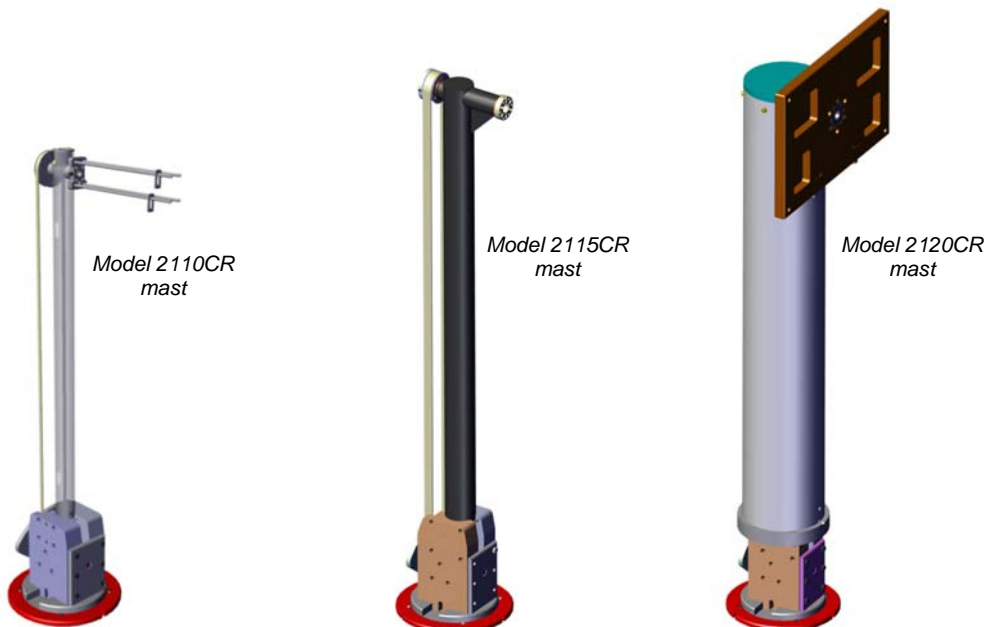

To minimize potential radio frequency (RF) obstruction or distortions of RF signals from low-directive wireless transmit antennas, the following features were implemented into the design of the CR MAPS:

- The use of minimum composite tube materials to fabricate the rotating shaft and mounts for Equipment Under Test (EUT).
- RF cable connection to the EUT is made through a 1.2-inch hole provided in the center of the roll axis shaft.

## Standard Configuration

---



**Note:** The CR MAPS mast assembly is incompatible with the 2110/2115 mast assembly due to a change in the gear ratio to facilitate the higher speed of the CR mast. To upgrade a standard mast to a CR mast, contact ETS-Lindgren.



**Note:** For part numbers, see *Replacement and Optional Parts* on page 16.

## MAST

The CR MAPS mast supports the EUT and provides continuous 360° rotation on the horizontal axis while keeping the EUT on the center of both rotation axes. The angular accuracy is guaranteed within  $\pm 0.25^\circ$  for both axes. The two axes can be controlled independently through the controller or measurement software.

## HORIZONTAL ROLL AXIS

The CR MAPS includes a horizontal roll axis for mounting EUT, and is equipped with mounting plates to secure the EUT or a Specific Anthropomorphic Mannequin (SAM) phantom head. Maximum EUT weight varies by CR MAPS model; see page 19 for weight specifications. The SAM phantom head for testing wireless handsets is optional.

## TURNTABLE

The CR MAPS includes a 63-in (160-cm) diameter circular wood deck that is bolted onto a motorized turntable. The deck has an opening for the vertical support and access to the knobs that clamp the sliding carrier into a fixed position.



## MOTOR BASES

The CR MAPS is equipped with two motor bases, one to control each rotational axis. The x-axis motor drive mounts onto a rail system that is attached to the turntable. This system is positioned on the turntable so that the x-axis centerline projects through the center of the turntable. The rail system has a sliding carrier that allows the vertical support assembly to be moved in or out, in a six-inch (15.2 cm) range, from the center of the turntable. The sliding carrier enables the movement of the EUT in or out in the same range.

A 230 VAC 50 or 60 Hz single-phase receptacle is required to power each motor base. Current draw is less than 4 amps per motor base. The drive power for both rotations is provided by the filtered 208–230 VAC, 50/60 Hz single-phase power inside the chamber. Therefore, there is no need for power drive cables to penetrate the shielded enclosure.

## FIBER OPTIC CABLES

To minimize any potential RF obstruction or distortion of RF signals from low-directive wireless transmit antennas, each CR MAPS is provided with fiber optic control lines that enable the I/O signal between the motor base and the positioning controller.

## TENSION SCALE

To measure the tension on the belt, a tension scale is included with the CR MAPS. You must use this scale to make sure there is no excessive tension on the belt.

See page 13 for the steps to measure and set the tension on the belt.



## Positioning Controller

---

A positioning controller such as the ETS-Lindgren EMCenter™ Modular RF Platform (with EMControl™ Positioner Controller Plug-In Card) is required for operation, and is sold separately. Contact ETS-Lindgren for ordering information. The EMCenter replaces the 2090 Controller, which has been discontinued. The basic controller configuration is an EMCenter with an EMControl card. This assembly is ETS part number 125241.

Check [ets-lindgren.com](http://ets-lindgren.com) or contact ETS-Lindgren to ensure that your EMCenter, the EMControl card, the backplane, and display all have the current firmware versions.

**EMCenter:** V5.21 (or later)  
**EMControl (7006-001) Card:** V2.5.6 (or later)  
**Backplane:** V2.3.0 (or later)  
**Display:** V1.4.10 (or later)

The EMCenter is also expandable with a variety of additional options available. Please contact ETS-Lindgren with any questions.



**Note:** Existing ETS-Lindgren positioning controllers can be used with the Model 2110CR/ 2115CR/ 2120CR; contact ETS-Lindgren to confirm your controller is installed with the required firmware.

The 2090 requires firmware revision V 3.21 or higher. It is available for download at [ets-lindgren.com](http://ets-lindgren.com) and requires the program Flash Upgrade Wizard V 4.0 (also available at [ets-lindgren.com](http://ets-lindgren.com)).



*EMCenter Modular RF Platform*

The positioning controller directs the motor drives for the upper roll (*phi* axis) and the rotation of the turntable (*theta* axis).

## **ETS-Lindgren Product Information Bulletin**

---

See the ETS-Lindgren *Product Information Bulletin* included with your shipment for the following:

- Warranty information
- Safety, regulatory, and other product marking information
- Steps to receive your shipment
- Steps to return a component for service
- ETS Lindgren calibration service
- ETS Lindgren contact information

This page intentionally left blank.

## 2.0 Maintenance

---



**CAUTION:** Before performing any maintenance, follow the safety information in the ETS-Lindgren *Product Information Bulletin* included with your shipment.



**CAUTION:** Do not perform maintenance while the CR MAPS is operating. During maintenance, disconnect power for safety.



**WARNING:** Only qualified individuals should conduct maintenance inspections or perform maintenance on the CR MAPS.



If you have any questions concerning maintenance, contact ETS-Lindgren Customer Service.

### Using the Tension Scale to Measure and Set Belt Tension

---



**CAUTION:** Do not over tighten the belt. Over tightening will reduce overall performance and cause component failure. The belt does not require a high degree of tension for normal operation.



**CAUTION:** Using the included tension scale, follow the steps in this section to set the belt tension for the CR MAPS: 48 oz maximum.



Located on the back of the mast is the belt tensioner. Use this to reduce or increase the tension on the belt.

1. Loosen the three belt tensioner bolts to release all tension on the belt.

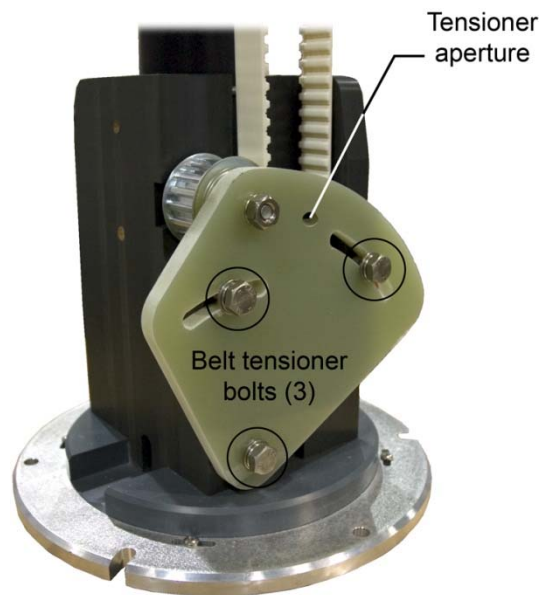

2. Attach the extension to the tension scale, and then insert the end of the extension into the tensioner aperture located on the belt tensioner.

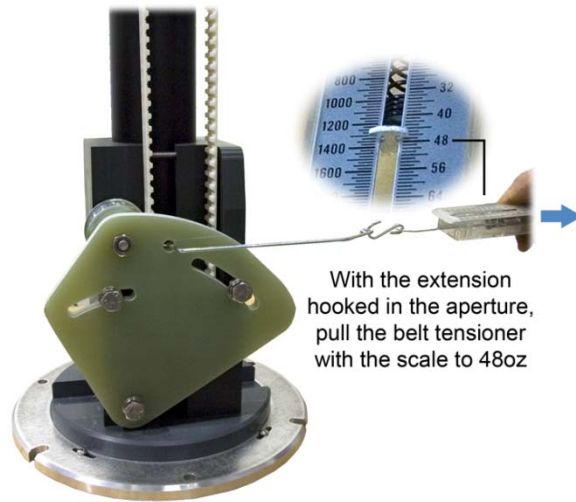

3. Pull the belt tensioner to the right with the scale until the scale reads 48 oz. This is the maximum belt tension recommended.

4. Holding the scale steady at 48 oz, re-tighten the belt tensioner bolts.

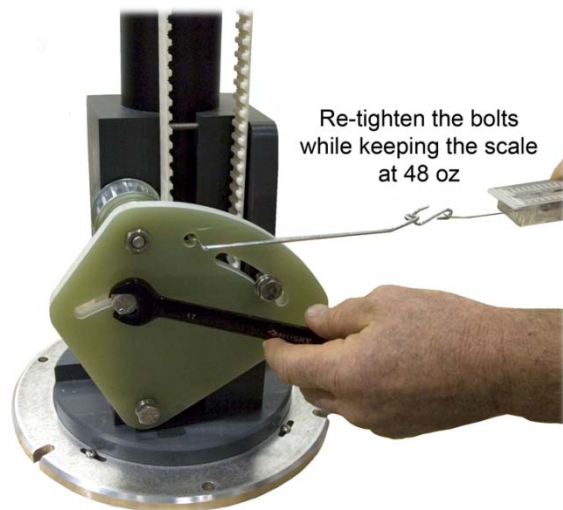

When all tensioner bolts are tightened, remove the extension from the aperture and place the scale in a safe, retrievable location.

## **Routine Maintenance**

---

Perform the following maintenance prior to each use:

- Visually inspect the Continuous Rotation (CR) Multi-Axis Positioning System (MAPS™) and surrounding absorber.

- Attempt to rotate each axis by hand. Excessive rotation may indicate a loose drive component.

During operation, listen for excessive or unusual noise.

### Bi-Annual Maintenance

---

Perform bi-annual maintenance every six months after the CR MAPS is placed into operation. Prior to maintenance, remove sufficient amounts of absorber to provide access to the casters.

Grease the turntable casters every six months or after every 2000 hours of operation. Use a good quality bearing grease and a standard SAE grease gun to lubricate the casters.

### Annual Maintenance

---

Perform the following maintenance every 12 months after the CR MAPS is placed into service:

- Use a good quality bearing grease to lubricate the turntable main bearing race. The grease fittings are located inside the race, 90° apart, under the top. Three discharges from the grease gun in each fitting are adequate.
- Use a good quality grease to lubricate the chain and sprocket of the chain drive.

### Replacement and Optional Parts

---

Following are the part numbers for ordering replacement or optional parts for the CR MAPS.

#### REPLACEMENT PARTS



**Note:** Specify height as *-NNNN*. For example:

- 72 inches is *-7200*
- 59.5 inches is *-5950*

Replacement Part Description	2110CR- <i>NNNN</i> Part Number	2115CR- <i>NNNN</i> Part Number	2120CR- <i>NNNN</i> Part Number
MAPS Turntable Assembly	111040		



<b>Replacement Part Description</b>	<b>2110CR-NNNN Part Number</b>	<b>2115CR-NNNN Part Number</b>	<b>2120CR-NNNN Part Number</b>
Mast Assembly	114839-NNNN	114492-NNNN	117745-NNNN
Mount Plate (2120CR only)	NA	NA	117830
Free Space Mount Kit (for light duty MAPS only)	107549	NA	NA
Tension Scale	705453		
Fiber Optic Cables, 10-meters	705344-10		
Fiber Optic Bulkhead Feedthrough	708027		

#### **OPTIONAL PARTS—2115CR ONLY**

<b>Optional Part Description</b>	<b>Part Number</b>
<b>SAM Phantom Head</b>	107182
<b>Phantom Hand, Left</b>	110209
<b>Phantom Hand, Right</b>	110208
<b>SAM Phantom Head Center Rotation Kit</b> Places center of the phantom head at the center of rotation of the upper axis	107550
<b>SAM Phantom Ear Rotation Kit</b> Places the left or right ear of the phantom head at the center of rotation of the upper axis	107551
<b>Free-Space Mount Kit</b> <ul style="list-style-type: none"> <li>• Medium duty free-space mount kit is not included with Model 2115CR Medium Duty MAPS mast assembly</li> <li>• Not compatible with Model 2110CR Light Duty MAPS mast assembly</li> </ul>	107559
<b>Laptop Mount</b> <ul style="list-style-type: none"> <li>• To mount laptop or similar device</li> <li>• EUT rotation axis is at center of EUT</li> </ul>	108279

Optional Part Description	Part Number	
<b>Mounting Adapters for Model 3160 Standard Gain Horn Antennas</b> <ul style="list-style-type: none"> <li>Requires antenna mount; also requires an extension to be attached to the rotating axle of the upper mast assembly</li> <li>If mounting two antennas that require the same extension, only one extension is required</li> </ul>		
	Antenna Mount	Extension
– 3160-05 Standard Gain Horn Antenna	110758	110759
– 3160-06 Standard Gain Horn Antenna	108416	108793
– 3160-07 Standard Gain Horn Antenna	108417	108793
– 3160-08 Standard Gain Horn Antenna	108418	108793
<b>Dipole Mount Base</b>		107505
<b>CTIA Ripple Antenna Mount Kit</b> <ul style="list-style-type: none"> <li>To mount loops and dipoles during the CTIA ripple test</li> <li>Specify height as –NNNN</li> </ul> <p>For example, 72 inches is –7200 and 59.5 inches is –5950</p>		107553-NNNN

## Service Procedures

### CONTACTING ETS-LINDGREN



**Note:** Please see [ets-lindgren.com](http://ets-lindgren.com) for a list of ETS-Lindgren offices, including phone and email contact information.

### SENDING A COMPONENT FOR SERVICE

For the steps to return a system or system component to ETS-Lindgren for service, see the *Product Information Bulletin* included with your shipment.

### CALIBRATION SERVICES AND ANNUAL CALIBRATION

See the *Product Information Bulletin* included with your shipment for information on ETS-Lindgren calibration services.

### 3.0 Specifications

#### Electrical Specifications

<b>Nominal AC Voltage:</b>	208–230 VAC
<b>Input Frequency:</b>	50/60 Hz
<b>Current Rating:</b>	10 amp service
<b>Phase:</b>	Single

#### Physical Specifications

See the assembly drawings located in the back pocket of the manual for additional dimensions.

<b>Unit Diameter:</b>	160.02 cm (63 in)
<b>Typical Turntable Platform Height:</b>	36.96 cm (14.55 in)
<b>Approximate Installed Unit Weight:</b>	453.59 kg (1000 lb)



**Note:** Contact your ETS-Lindgren sales representative for shipping container dimensions and weight.

#### Mast Specifications

	<b>Model 2110CR (including Free Space Mount 107549)</b>	<b>Model 2115CR</b>	<b>Model 2120CR</b>
<b>Height:</b>	Customer-specified		
<b>Maximum EUT Size (within the area of the provided mount):</b>	0.45 kg (1 lb)	11.3 kg (25 lb)	34 kg (75 lb)

This page intentionally left blank.

## 4.0 Electrical Installation

---



**CAUTION:** Before assembling, installing, or connecting any components, follow the safety information in the ETS-Lindgren *Product Information Bulletin* included with your shipment.



**Electrical installation must be performed by a qualified electrician, and in accordance with local and national electrical standards**



**Make sure the power is off and secured before proceeding**

The Continuous Rotation (CR) Multi-Axis Positioning System (MAPS™) is designed to operate using 208–230 VAC single-phase 50 or 60 Hz power.

1. The branch circuit supplying power to the motor bases must be protected from excess current according to local electrical codes. Integral circuit protection is provided in the motor base assembly.
2. Make sure the conductor size is adequate for the motor load and the distance from the mains source. Improperly sized conductors will lead to a high voltage drop in the power conductors and cause reduced starting torque and premature motor failure.
3. The motor base assembly is provided with an IEC-320 power inlet for connecting to the mains.
4. Connect the fiber optic control cable and install the power connection according to local electrical code. See the controller manual for information on connecting the fiber optic cable. After the fiber optic cable is installed, secure it with a wire tie to one of the leveling screws.

This page intentionally left blank.

## 5.0 Installation

---



**CAUTION:** Before connecting any components, follow the safety information in the ETS-Lindgren *Product Information Bulletin* included with your shipment.



Proper installation of the CR MAPS directly affects performance. The installation must be performed by factory installation specialists or individuals authorized by ETS-Lindgren to perform installation. This information provided in this manual is intended to be used only by those installation specialists.

See the assembly drawings located in the back pocket of the manual to assist with installation.



**Note:** The CR MAPS mast assembly is incompatible with the 2110/2115 mast assembly due to a change in the gear ratio to facilitate the higher speed of the CR mast. To upgrade a standard mast to a CR mast, contact ETS-Lindgren.

The installation of the Continuous Rotation (CR) Multi-Axis Positioning System (MAPS™) will take approximately eight hours and will require a minimum of two people.

If you have any questions concerning installation, contact ETS-Lindgren Customer Service for Customer Service contact information.

### Required Tools

---

The following tools are required to install the CR MAPS:

- Power hand drill, 3/8-in chuck
- Drill bit, 3/16-in diameter
- Drive bit, square (provided)
- Drive bit, #2 Phillips
- SAE hex key wrench set (maximum 1/2-in)
- Permanent marker

- Laser level, 5-beam, and stand
- Bubble level (36-in minimum)
- 10-in adjustable, open-ended wrench

## Reference Point

---



**Note: If installing the CR MAPS in an existing chamber:** Remove the absorber from the floor and lower wall areas prior to installation to avoid damage to the absorber.

1. Locate the reference point. It is generally located along the bore sight axis of the range antenna. See *Bore Sight and Leveling* on page 29 for additional information regarding bore sight.
2. With permanent marker, place an **X** on the floor of the chamber at the reference point.

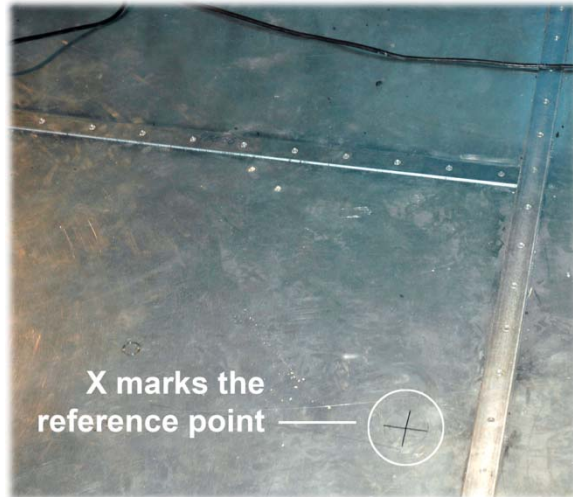

3. Draw a 47-in (1.19-m) diameter circle to represent the turntable perimeter.



**Note:** The diameter is larger than the actual perimeter of the circular anchor plates for the turntable, and should only be used as a guide in centering the turntable portion of the CR MAPS.



## System Installation

---



**CAUTION:** Fiber optic cables must be connected correctly for motor base function. Before removing fiber optic cables from the motor base, label the replacement locations for accurate reconnection.

1. Remove the wood deck. See assembly drawing 110073 located in the back pocket of the manual for details.
2. The drive units are designed to move from the shipping container to the chamber floor as a single unit. If you cannot move it as a single unit without causing damage, separate the upper drive unit. See *Upper Drive Unit Removal* on page 27.

3. Place on the chamber floor within the drawn circle.

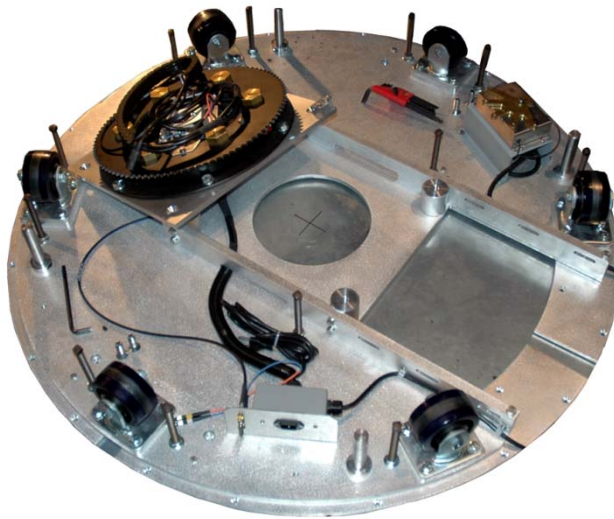

**Note:** When installing the turntable on modular shielding, do not drill anchor holes through the floor joint strips. Use the shim plates provided.

4. Insert the shim plates to level the turntable over the vault seams.

## ANCHOR PLATE INSTALLATION

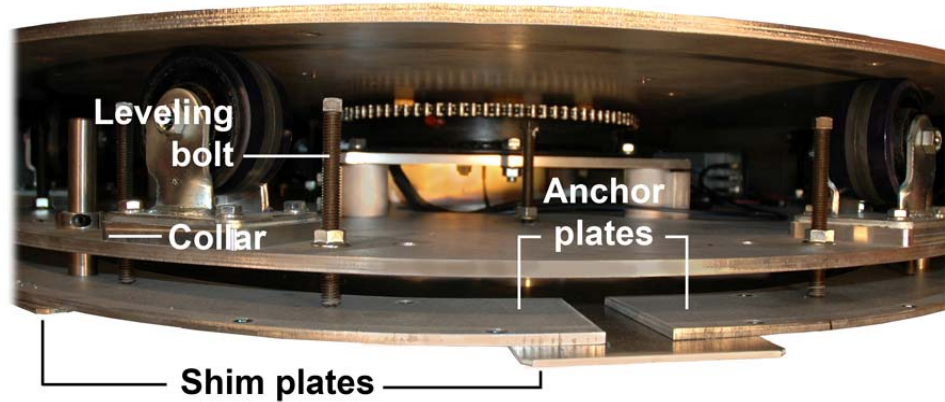

1. The anchor plates are held in place by 1/4–20 screws and set collars. Screw the anchor plates to the floor using 14x1 square socket flat head screws.  
  
Drill pilot holes for these screws, and make sure to vacuum shavings to provide good contact with the floor. Continue mounting the remainder of the plates.
2. When all anchor plates are securely mounted, remove the 1/4–20 screws that hold the anchor plates to the base. Discard the screws.
3. Use a bubble level to verify the turntable unit is flat. This is a preliminary check only; final leveling of the turntable will be completed in a later step.
4. Use shim plates to level the table. The shim plates will remain in place after the installation.

## UPPER DRIVE UNIT REMOVAL

When installing the CR MAPS in an existing chamber, it may be necessary to remove the upper drive unit to avoid damage to the chamber or to the u.

Following are the steps to separate the upper and lower drive units. See assembly drawings 111040, 109987, and 110073 located in the back pocket of the manual for details.

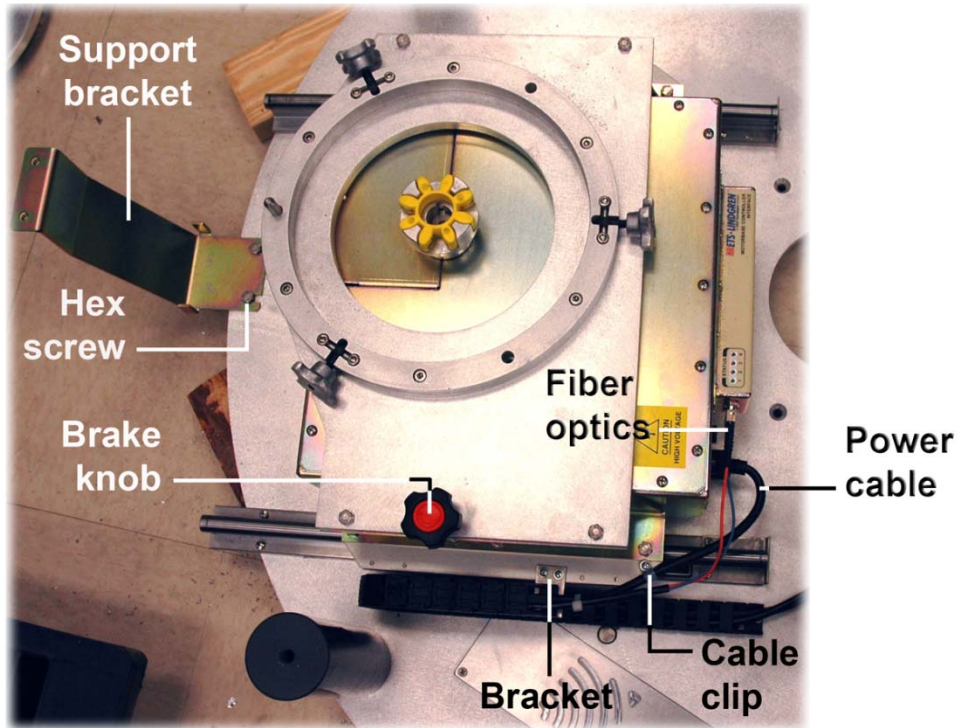

1. Prior to disconnecting the fiber optic cables from the upper drive unit, label and mark the locations for reconnection.
2. Verify the fiber optic cables to the upper motor base are not switched.
3. Remove the bracket mounted on the drive unit that is attached to cable carrier. Two #6 screws hold the bracket to the unit.
4. Remove the cable clip holding the power cable.
5. Remove the bracket on the opposite side of the unit that ties the drive unit to the turntable top. This temporary bracket holds the unit in place for shipping.

6. Turn the brake knob to release the drive unit and allow it to move toward center of table.



**Note:** When the turntable top is in place, use the brake knob to adjust the Equipment Under Test (EUT) to the center of rotation (middle of the quiet zone) by sliding the mast assembly back and forth.

7. Remove the two 1/4–20 hex head screws that hold the wood top support bracket, and then remove the bracket.
8. Slide the drive unit carrier out.
9. Reinstall in reverse order.



**Note:** The brake knob must be in the upper position to allow the drive unit to slide onto the rail system. Verify all hardware is secured.

## Bore Sight and Leveling

---



**Note:** If the CR MAPS was ordered with multiple masts, you must bore sight each mast.

### BORE SIGHT

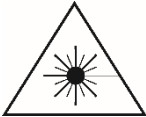

**LASER WARNING.** Denotes a laser is part of the operating system of the device.



Bore sight is critical to the accuracy of measurements, and is the most important step of the installation process. Take the time to verify all measurements are accurate.

To make sure the CR MAPS is level with the antennas in the chamber and is accurately centered in the chamber, install the mast. Bore sight requires a five-beam laser level.

Following are the typical installation steps used to achieve bore sight.

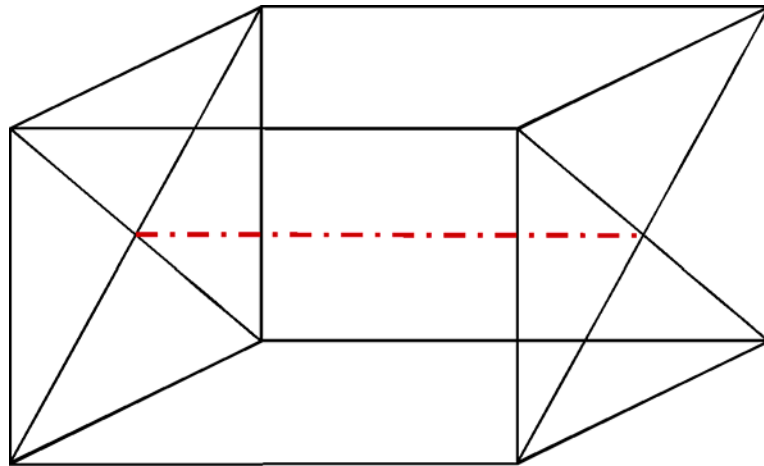

Locate center of chamber

1. Locate and mark the center of the chamber wall opposite the range antenna mounted in the chamber end wall. Marking may require the removal of absorber.

This applies for both rectangular and tapered chambers. In tapered chambers the antenna is mounted in the far end of the antenna apex. In both cases the typical installation of the antenna is parallel to the cross section of the opposite end wall.

If the range antenna is mounted elsewhere in the chamber, then the bore sight line exists normal to the middle of the range antenna.

2. With the laser mounted on a tripod, mark the end of the bore sight line to the end wall for reference.

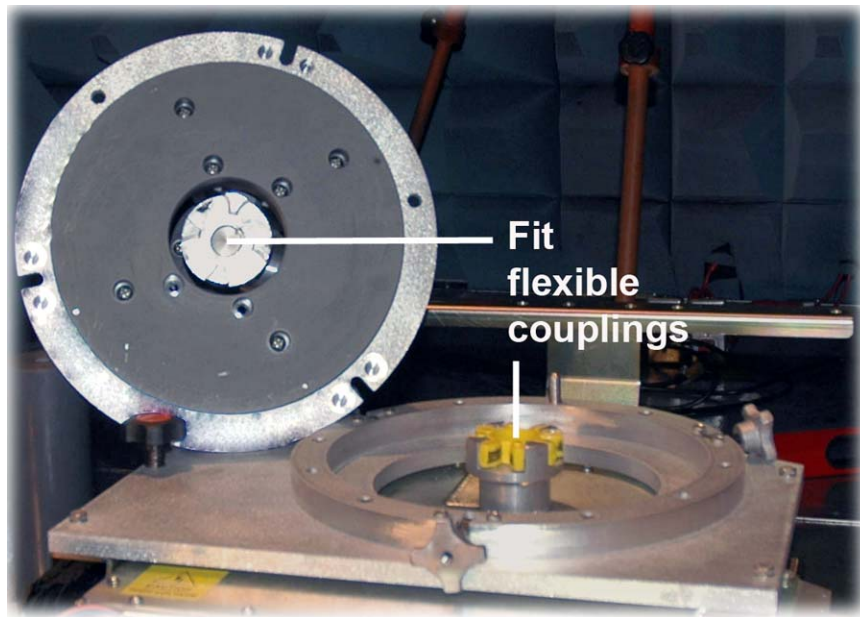

**Fit the flexible couplings of the mast and turntable together**

3. Install the mast. Line up the flexible couplings and slide the mast into position.



**Slide the aluminum knobs over the collar of the mast**

4. After the couplings are aligned and the mast is fitted securely to the turntable top, slide the aluminum hand knobs over the collar and tighten.

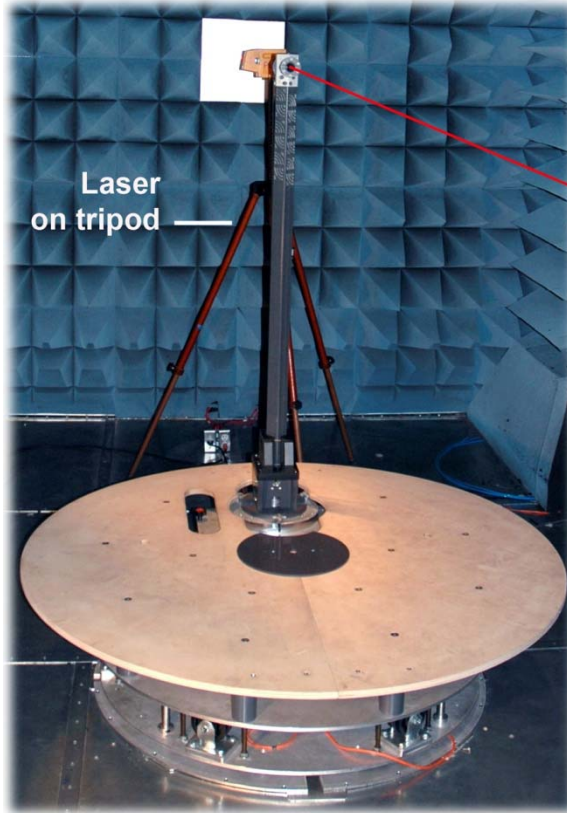

**Align laser through the mast mount to the center of the chamber**

*(Model 2115 shown)*

5. When the knobs are securely in place, unit so that the center of the horizontal axis is aligned with the laser beam.

Small height corrections may be necessary. For information, see *Leveling and Height Adjustment* on page 34. After the system is leveled, additional height corrections may be required.



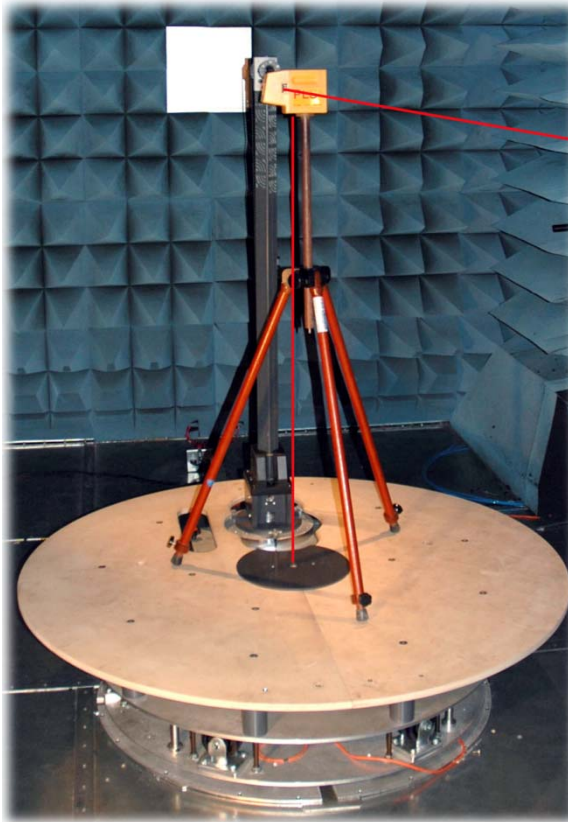

**Laser and tripod on turntable top**

*(Model 2115 shown with optional dipole mount plate)*

6. Mount the laser onto a tripod, and then place it on the turntable top.
7. Sight one horizontal laser in line with the antenna mounted in the end wall of the chamber.

Align the opposite side of the horizontal laser through the mounting gear to the center of the opposite end wall and to the reference point previously marked.

Align the vertical laser with the center of the dipole pole mount plate (optional) or the deck to the center axis of the bore sight line. The center of the deck is located between the two closest screws attaching the plywood deck to the bottom spacers.

8. Verify that the laser beam is visible through the horizontal axis while the mast is moved back and forth in the slider system.
9. Achieve bore sight for each mast to be used.

## LEVELING AND HEIGHT ADJUSTMENT

If during the bore sight process it is determined that the unit must be leveled or the height adjusted, follow these steps.

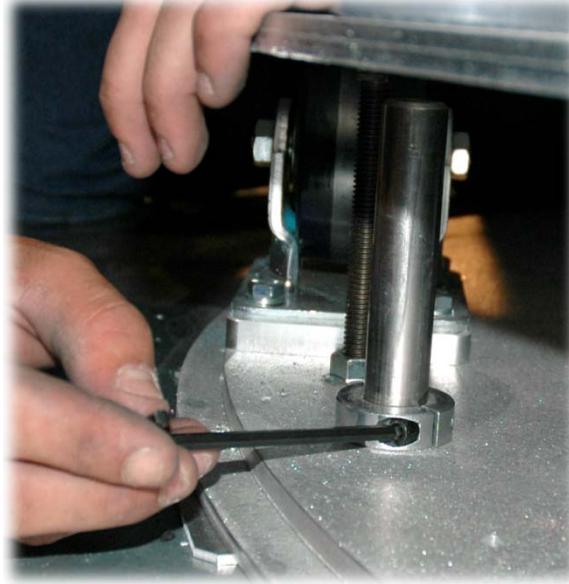

Loosen collar on the anchor shafts

1. Use a 3/16 hex key wrench to loosen the collar on the anchor shafts.

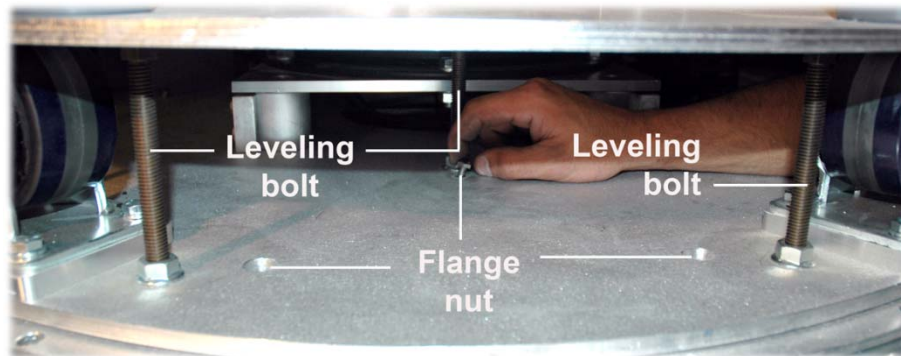

Remove flange nuts, then raise or lower leveling bolts

2. Use an open-ended wrench to loosen the flange nuts on all leveling bolts.
3. Lower or raise the leveling bolts to set the turntable to the correct height. Begin leveling from two opposing sides.

4. When the level is accurate, move the remaining leveling bolts into the correct position.



**Note:** If installing the CR MAPS in a pit, mark the amount required to raise the unit up to level. Remove the top of the turntable and begin leveling.

5. Verify that the unit is level.

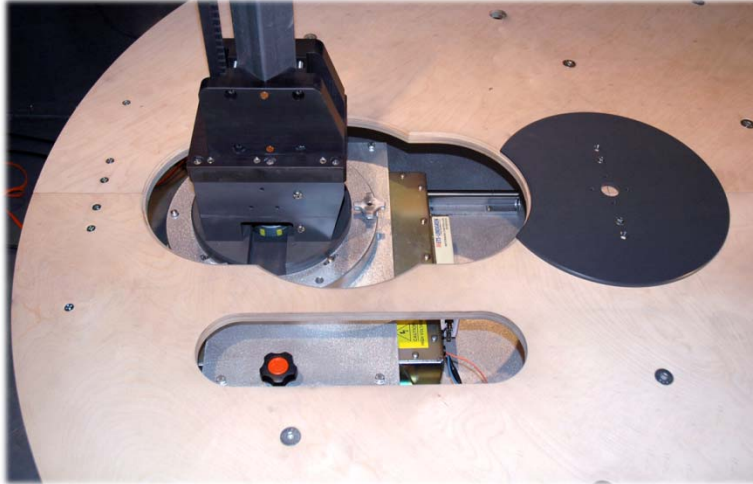

**Attach the wooden turntable top**  
*(Shown with optional dipole mount base)*

6. Position the wooden turntable top on the turntable base.
7. Use a 5/16 Allen wrench to tighten the bolts.
8. Secure the turntable top seams in place with a Phillips screwdriver.

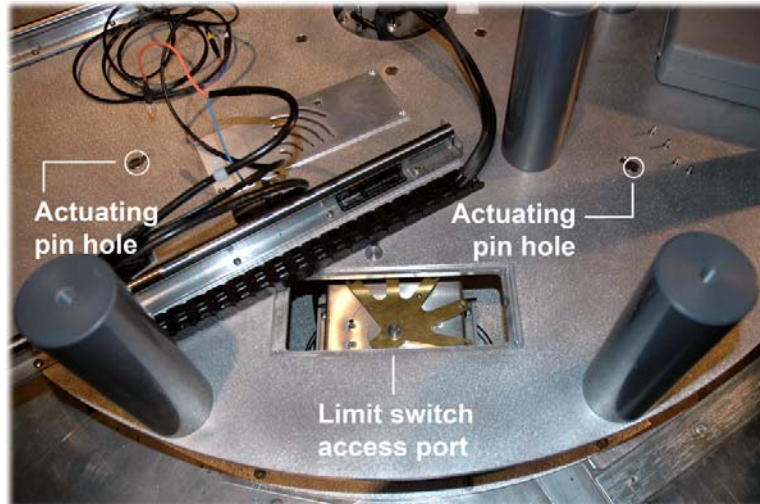

**Position the actuating pins on each side of the limit switch access port**

9. Verify the access port is located over the limit switch.
10. Position the actuating pins in the holes on each side of the access port.

### **Controller Interface**

---

For information about connecting fiber optic cables from the CR MAPS to the positioning controller, see the controller manual.

### **Absorber Installation**

---

After the leveling and bore sight is achieved, position the absorber that surrounds and covers the unit. For absorber locations, see the *Top View of Wood Deck with Absorber Locations* assembly drawing located in the back pocket of the manual.

## 6.0 Operation

---



**CAUTION:** Before placing into operation, follow the safety information in the ETS-Lindgren *Product Information Bulletin* included with your shipment.



**Note:** The CR MAPS mast assembly is incompatible with the 2110/2115 mast assembly due to a change in the gear ratio to facilitate the higher speed of the CR mast. To upgrade a standard mast to a CR mast, contact ETS-Lindgren.

If you are unfamiliar with the operation of the EMCenter™ Modular RF Platform (with EMControl™ Positioner Controller Plug-In Card), see the manual included with the controller. Each manual is also available for download from [ets-lindgren.com](http://ets-lindgren.com).

With the installation of the Continuous Rotation (CR) Multi-Axis Positioning System (MAPS™) complete, the controller must be connected to the unit and power applied to both the motor base and controller. See the controller manual for information on connecting the fiber optic cable.

Use the controller to check the clockwise (CW) and counterclockwise (CCW) rotation in both directions by a few degrees. The position in degrees increases (+) in the CW direction and decreases (-) in CCW direction.

### EMCenter Parameter Settings

---

Encoder calibration for the positioners is 3600 and should be entered into the configuration page on the EMControl™.

For all other parameter settings, refer to the *EMControl™ Positioner Controller Plug-In Card User Manual*, available for download from [ets-lindgren.com](http://ets-lindgren.com).



**Note:** If you are unfamiliar with the operation of the EMCenter, see the manual, available for download from [ets-lindgren.com](http://ets-lindgren.com).

The EMCenter replaces the 2090 Controller, which has been discontinued.

The 2090 requires firmware revision V 3.21 or higher. It is available for download at [ets-lindgren.com](http://ets-lindgren.com) and requires the program Flash Upgrade Wizard V 4.0 (also available at [ets-lindgren.com](http://ets-lindgren.com)).

## Appendix A: Warranty

---



**Note:** See the *Product Information Bulletin* included with your shipment for the complete ETS-Lindgren warranty for your CR MAPS.

### Duration of Warranties

---

All product warranties, except the warranty of title, and all remedies for warranty failures are limited to two years.

Product Warranted	Duration of Warranty Period
Model 2110CR Continuous Rotation Multi-Axis Positioning System (MAPS™)	2 Years
Model 2115CR Continuous Rotation Multi-Axis Positioning System (MAPS™)	2 Years
Model 2120CR Continuous Rotation Multi-Axis Positioning System (MAPS™)	2 Years

This page intentionally left blank.

## **Appendix B: Assembly Drawings**

---

The following assembly drawings are located in the back pocket of the manual:

- 114820 (4 pages)—Model 2110CR Mast Assembly
- 114491 (4 pages)—Model 2115CR Mast Assembly
- 117840 (4 pages)—Model 2120CR Mast Assembly
- 117830—Model 2120CR Mount Plate
- 109987—MAPS Slider Assembly
- 110073—MAPS Turntable Top Sub-Assembly
- 111040 (2 pages)—MAPS Turntable Assembly
- Top View of Wooden Deck with Absorber Locations